

**NOTE: ALL MATERIAL COMPLIANT ROHS STANDARD**

REVISION INFORMATION			
Rev.	Rev. Date	Modified By	Brief Description

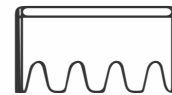
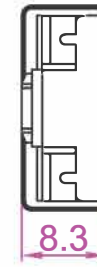
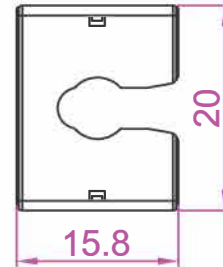
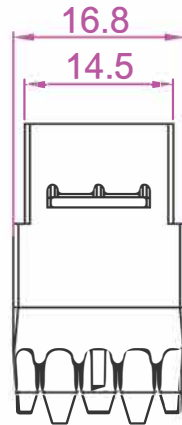
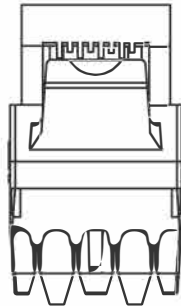
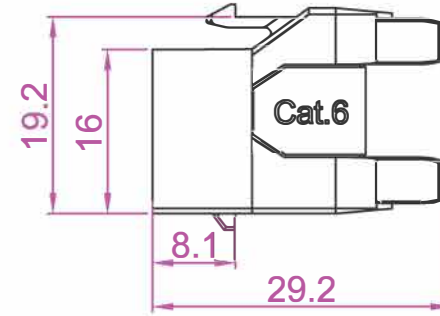
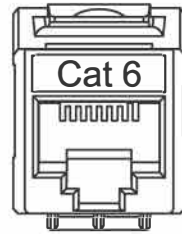
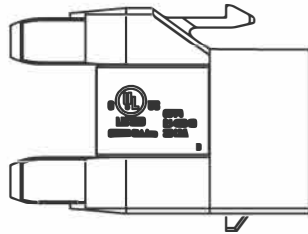

**IDC CAP**

ACCORDING TO ANSI/TIA-568-C.2  
REQUIREMENTS  
C6 CHANNEL COMPLIANT

**Cat 6**

56Y4  
E145249



COMMUNICATION  
CIRCUIT ACCESSORIES

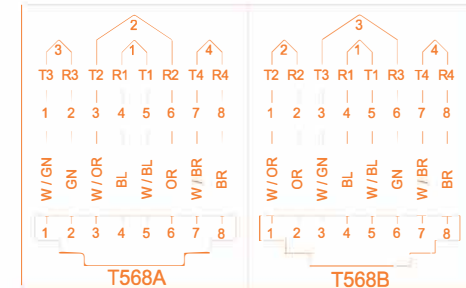

**MATERIAL**

KEYSTONE JACK HOUSING: PC HIGH-IMPACT UL94V-0 THERMOPLASTIC.  
SPRING PIN: PHOSPHOR BRONZE C5210-EH, T=0.3mm.  
PLATING: NICKEL UNDERCOAT,  
BESIDES PLATING 50U" GOLD OVER THE PLATED SURFACE ON CONTACT AREA.  
IDC HOUSING: PC HIGH-IMPACT UL94V-0 THERMOPLASTIC.  
IDC CONTACT: PHOSPHOR BRONZE C5191R-H, T=0.4MM, PLATING 100U" SOFT NICKEL.  
PCB: FR-4

**PHYSICAL CHARACTERISTICS**

INSERTION LIFE: 750 MATING CYCLES WITH FCC COMPLIANT 8P PLUG.  
CONTACT FORCE: 100 GRAMS WITH FCC COMPLIANT 8P PLUG.  
PLUG RETENTION FORCE: 11 LBF MIN.  
DURABILITY: 200 TERMINATION CYCLES.  
CONTACT COMPATIBILITY: ACCOMMODATES 22 TO 24 AWG SOLID.  
OPERATING TEMPERATURE RANGE: -10°C TO 60°C.  
STORAGE TEMPERATURE RANGE: -40°C TO 68°C.  
HUMIDITY: 10%~90% RH.

**ELECTRICAL**

INSULATION RESISTANCE: 500 M Ω.  
DIELECTRIC WITHSTANDING VOLTAGE: 1000V AC.  
DC CURRENT RATING: 1.5 Amps.  
DC RESISTANCE: 0.1 Ω.  
CONTACT RESISTANCE: 20mΩ.



**LANshack**  
Sales@LANshack.com | 888-568-1230

NO.	PART NAME	SPECIFICATION DESCRIPTION	QTY	UNIT
③				
②				
①	IDC Cap	20*15.8*8.3mm	1	PCS

Unless specified on the drawing, tolerances are per the follows:  
.x +1  
+0.2  
.xx +0.05

<b>DRAWN BY</b> WJH	<b>DATE:</b> 2018-5-3	<b>DESCRIPTION:</b> Cat.6 RJ45 110 Type 180° Keystone Jack
<b>CHECKED BY</b>	SHEET 1 of 1	<b>ITEM NO.</b> LSBL-110KST-C6
<b>APPROVED BY</b>	SCALE 4:3	<b>REV. 00</b> <b>UNIT:</b> mm